

Indoor environment monitor with I2C compatible interface

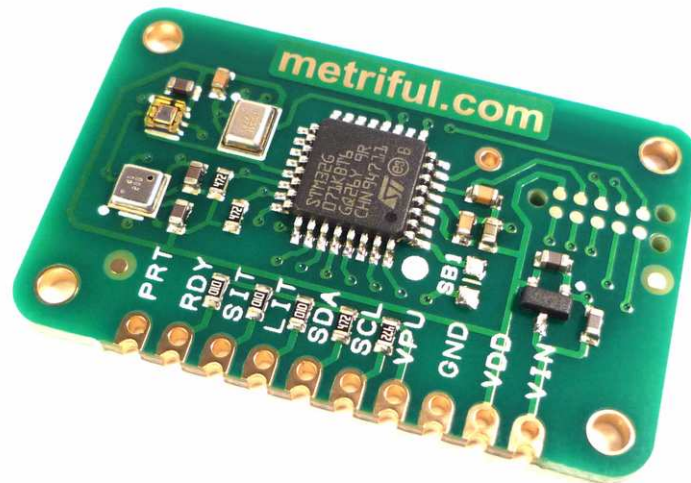

DESCRIPTION

The Metriful MS430 is a low power, high accuracy, smart sensor cluster for indoor environment monitoring. It is operated via a simple I2C-compatible interface and measures eighteen variables including air quality, light and sound levels. The MS430 also offers an active interrupt feature to reduce burden on the host system.

SUMMARY

- Indoor environment monitoring with air quality, sound and light measurements
- Compatible host systems include Arduino and Raspberry Pi
- Automated set-up and ongoing management of sensors
- On-board data analysis using intelligent algorithms

FEATURES

- Through-hole connections or surface mountable
- Dimensions (Lx W x H in mm): 37.5 x 23.4 x 3.1
- Suitable for 3.3 V and 5.0 V systems
- RoHS compliant

APPLICATIONS

- Air quality monitoring
- Home automation
- Internet of Things
- Context awareness

CONTENTS

1. FURTHER INFORMATION.....	3
2. HANDLING PRECAUTIONS.....	3
3. BOARD FEATURES AND CONNECTIONS.....	4
4. OPERATIONAL MODE DESCRIPTIONS.....	4
Standby mode.....	4
Cycle mode.....	5
5. INPUT VOLTAGE REQUIREMENTS.....	5
Main power supply: VIN or VDD.....	5
Pull-up voltage: VPU.....	5
6. TWO-WIRE COMMUNICATIONS INTERFACE.....	5
Registers.....	5
MS430 board address.....	6
Data bit and byte order.....	6
Fractional data representation.....	6
Signed temperature data.....	7
Transaction queueing.....	8
Interface disabled periods.....	8
Sound and light interrupt threshold programming.....	8
Executable command example.....	8
Settings register read/write examples.....	9
Environment data read examples.....	9
7. OUTPUT SIGNAL LINES: RDY, LIT, SIT.....	10
8. ON-DEMAND MEASUREMENTS.....	11
9. CYCLE MODE.....	11
Initial configuration and entry into cycle mode.....	11
Ongoing cycle mode procedure.....	12
10. TIMING CHARACTERISTICS.....	12
11. DEVICE CHARACTERISTICS.....	15
Absolute maximum ratings.....	15
Basic characteristics.....	15
12. PARTICLE SENSORS.....	16
PPD42.....	16
SDS011.....	17
13. INTERRUPTS.....	17
Light level interrupt (output labeled LIT).....	17
Sound level interrupt (output labeled SIT).....	17
Interrupt type: latch or comparator.....	17
Interrupt configuration and enabling.....	17
Interrupt control.....	18
14. HOST RESET AND DEVICE INITIALIZATION.....	18
15. REGISTER LISTINGS.....	19
Executable command registers.....	19
Settings registers.....	20
Environment data category registers.....	21
Individual environment data registers.....	22
16. SENSOR COMPONENTS.....	24
17. RoHS.....	24
18. DISCLAIMER.....	25

1. FURTHER INFORMATION

To achieve the fastest development time, use this datasheet together with the following resources which can be found at www.github.com/metriful/sensor.

- User Guide, showing how to use the MS430 with host systems including Arduino and Raspberry Pi. It also explains the meaning, interpretation and use of the measured environment data.
- Demo code, examples and instructions to help you get started immediately.

2. HANDLING PRECAUTIONS

The MS430 can be damaged by static electricity discharges. Minimize this risk by observing the following precautions:

- Handle the board by the edges
- Avoid touching any metal part of the device or circuit it connects to
- Store in the provided antistatic bag when not connected in a circuit
- Keep away from metal objects which could cause shorted connections

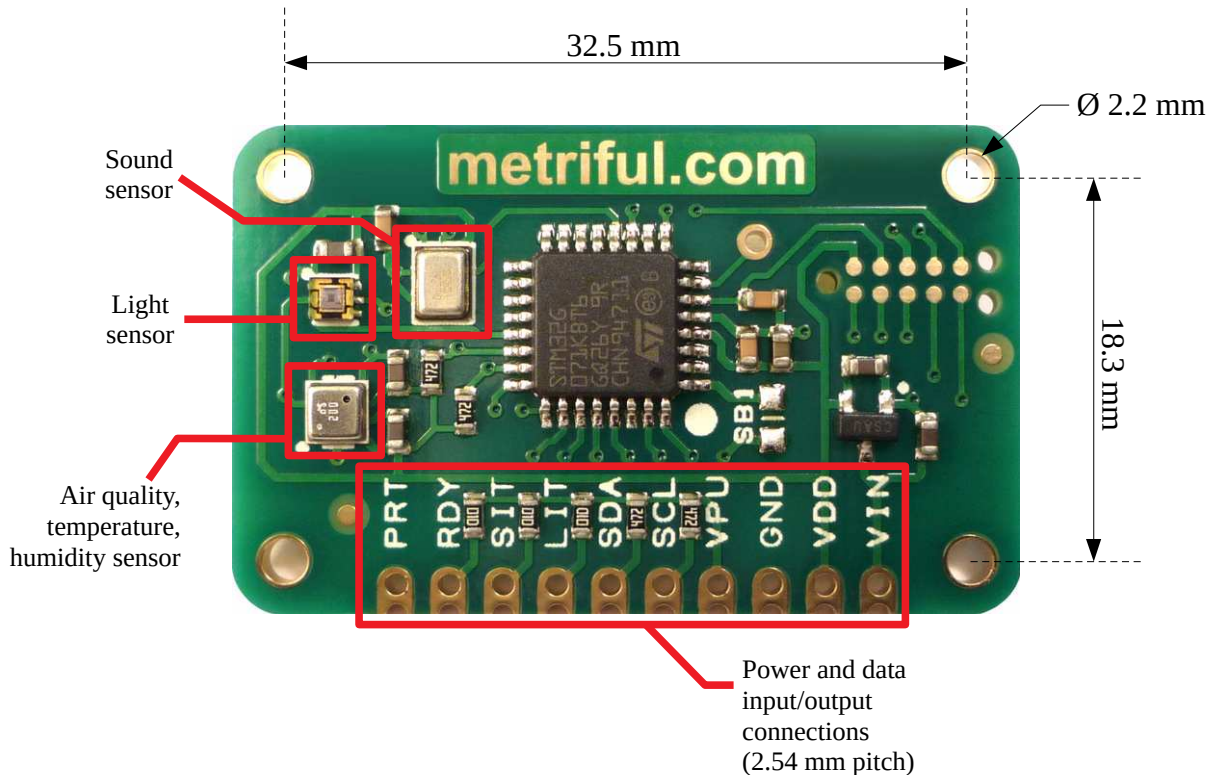

Figure 1 - Position of sensors and mounting holes on the MS430 circuit board.

3. BOARD FEATURES AND CONNECTIONS

The positions of individual sensors on the MS430 circuit board are shown in Figure 1, which also shows size and position of the mounting holes. The overall board dimensions are 37.5 mm x 23.4 mm x 3.1 mm. The ten-terminal connector has 2.54 mm (0.1") pitch through-holes combined with plated edge contacts. These allow the fitting of header pins (ideal for breadboards or jumper wires) or surface-mount soldering. Table 1 lists the function and voltage range of each of these connections.

Table 1 - Board connections and nominal voltages when in use.

Pin number	Label	Min. voltage	Max. voltage	Description
1	VIN	3.7	6.0	Power input if no 3.3 V supply is available. Leave unconnected if VDD is used.
2	VDD	3.3	3.3	Power input for 3.3 V supply. Leave unconnected if VIN is used.
3	GND	0	0	0 V ground
4	VPU	3.3	5.0	Pull-up voltage input. Apply the host system voltage.
5	SCL	0	VPU	Two-wire interface (I2C compatible) clock input
6	SDA	0	VPU	Two-wire interface (I2C compatible) data input/output
7	LIT	0	VPU	Light interrupt signal output (optional)
8	SIT	0	VPU	Sound interrupt signal output (optional)
9	RDY	0	VPU	READY signal output
10	PRT	0	5.0	PPD42 particle sensor signal input (optional)

4. OPERATIONAL MODE DESCRIPTIONS

The MS430 has two modes of operation: **standby** and **cycle**, offering a choice of convenience and customization. User commands can switch between these modes.

Standby mode

- All user-editable system parameters can be configured
- Sensor measurements can be triggered at any time (“on-demand”) by the host system. Note that air quality data are not available from on-demand measurements

Cycle mode

- Sensor measurements occur at fixed time intervals in a repeating cycle (every 3, 100, or 300 seconds)
- The measurement cycles are self-triggering without ongoing host intervention
- Choose longer cycle period for lower power consumption and/or lower data bandwidth
- The host system is alerted when new data are available

5. INPUT VOLTAGE REQUIREMENTS

The MS430 is fully compatible with host systems running at 3.3 V or 5 V, allowing use with popular prototyping platforms such as Raspberry Pi, Arduino, BBC micro:bit, as well as thousands more microcontroller and embedded computer systems.

The board must be supplied with two voltage inputs, main and pull-up:

Main power supply: VIN or VDD.

- If a 3.3 V supply is available, this is connected to VDD and the VIN input is left unconnected.
- If a supply in the range 3.7 V – 6 V is available, this is connected to VIN and the VDD input is left unconnected.
- **Do not apply more than 3.3 V to VDD, or more than 6 V to VIN.**

Pull-up voltage: VPU

- This is used to match the MS430 input/output lines to the host system voltage.
- Connect the host system voltage (either 3.3 V or 5 V) to the VPU input.
- **Do not apply more than 5 V to VPU**

6. TWO-WIRE COMMUNICATIONS INTERFACE

The MS430 communicates with the host system via an I2C-compatible two-wire interface (labeled SDA and SCL), which is used to exchange commands and data. Each transaction through this interface involves a standard read/write from/to a specific register address, with the MS430 acting as the slave device. No external pull-up resistors are needed as the board provides 4.7 k Ω pull-ups to VPU on SCL and SDA. The MS430 does not clock-stretch the SCL line.

Registers

A complete list of registers is given in Section 15. There are three types of register:

- **Settings register (read/write)**
This is a standard read/write register, used to change operational parameters. The register address byte is written to the MS430, followed by a read or write of the data bytes. Some settings registers may only be changed in standby mode.

- **Executable command (write-only)**

A write to one of these registers triggers a control action, such as clearing an interrupt. The register address byte is written to the MS430, without sending any accompanying data bytes. Any data bytes which are written are ignored and will result in a bus NACK (although the command will still execute successfully). Reads of these registers are ignored.

- **Environment data (read-only)**

This is a standard read-only register, used by the host to obtain the measured environment data. The register address byte is written to the MS430, followed by a read of the data bytes. Writes to these registers are ignored and will result in a bus NACK.

MS430 board address

The default 7-bit address of the MS430 board is 0x71. When this is used in a I2C-compatible read or write command, the 8-bit address word is 0xE3 or 0xE2, respectively.

If a different address is required, the solder bridge labeled SB1 may be soldered closed, making the 7-bit address 0x70 and the corresponding 8-bit address words 0xE1 and 0xE0 for read and write, respectively.

Data bit and byte order

Each byte (8 bits) of data is always sent **most-significant bit** first. If a value is represented by more than 8 bits (e.g. the measured pressure is a 32-bit number = 4 bytes), the number is sent as a sequence of single bytes, **least-significant byte** first. E.g. the decimal number 4238 as a 16-bit hexadecimal number is 0x108E. This is sent as a sequence of two bytes where the first byte is 0x8E and the second byte is 0x10.

Fractional data representation

Due to the use of standard measurement units, many of the output environment data values are fractional. Rather than use standard floating point number representation (wasteful of memory and processing time), the MS430 uses the simple fixed decimal point representation **A.B** where A is the integer part of the measurement and B is the fractional part (the number following the decimal point). Parts A and B are read by the host as two integers.

Integer A is either 8-bit or 16-bit, while B is always an 8-bit integer. It is also necessary to know the number of decimal places (1 or 2) represented by B. Both details are listed in Table 2.

Table 2 - Fractional data representation details for environment data.

Measured quantity	Bit depth of A	Decimal places in B
Temperature*	8	1
Humidity	8	1
Air Quality Index	16	1
Estimated CO ₂	16	1
Equivalent breath VOC	16	2
Illuminance	16	2
Sound pressure levels	8	1
Peak sound amplitude	16	2
Particle sensor duty cycle	8	2
Particle concentration	16	2

*The A value for temperature is also sign-encoded, as explained in the next section.

Signed temperature data

The temperature measurement is the only data value which can be negative. The 8-bit “A” part of the A.B temperature value contains a most-significant sign bit, followed by a 7-bit integer. A sign bit of 1 indicates a negative temperature, while a 0 indicates a positive temperature. The remaining 7 bits give a value from 0 – 127 which is the integer part of the temperature value in degrees Celsius. B is the usual fractional part, to one decimal place.

Examples:

- Temperature bytes read as: A = 0x82, B = 0x06
A in binary is 0b10000010. The most significant bit is 1, indicating a negative temperature.
The 7-bit integer 0b0000010 is 2, and B is 6.
The temperature is therefore: **-2.6 °C**
- Temperature bytes read as: A = 0x12, B = 0x09
A in binary is 0b00010010. The most significant bit is 0, indicating a positive temperature.
The 7-bit integer 0b0010010 is 18, and B is 9.
The temperature is therefore: **18.9 °C**

Examples of temperature decoding in the Python and C/C++ programming languages are given in the demo code samples at www.github.com/metriful/sensor.

Transaction queueing

Write transactions (executable commands and writes to settings registers) require processing by the MS430 and are not fully completed at the point at which activity on the two-wire bus stops.

Sending multiple write transactions with minimal intervening delay will cause the later transactions to be queued (but will still process correctly). In situations where the later command depends on full completion of the previous one, the host should pause (for at least 6 ms) to allow for processing before sending the later command. In particular, this pause is required before each of the following cases:

- Repeating the same write transaction a second time.
- Reading back the contents of a register which has just been written.

Interface disabled periods

The two-wire interface is briefly disabled in the following situations:

- During an on-demand sensor measurement
- During a mode change between standby and cycle mode

These periods are indicated by deassertion of the READY signal. The MS430 will NACK all attempted communications during this time and cannot respond to commands. The timing of these disabled periods is specified in Table 3. In both cases, the host system should wait for re-assertion of READY before attempting to use the two-wire interface.

Sound and light interrupt threshold programming

The sound and light interrupt thresholds are the only writable values represented by more than one byte (two bytes for sound and three for light). In these cases, all bytes must be written in a single I2C transaction (e.g. cannot write only one byte of the 2-byte sound interrupt threshold). The MS430 will ignore incomplete values.

The light interrupt threshold has a maximum settable value of 3774.0 lux. Any value larger than this will be ignored and the previous value retained.

Python and C/C++ functions for setting the interrupt thresholds are given in the demo code samples at www.github.com/metriful/sensor.

Executable command example

- Trigger an on-demand measurement (only valid in standby mode, and explained in Section 8)

Master sends the START condition

Master sends 0xE2 (7-bit slave address of 0x71 combined with a R/W bit of 0)

Slave sends ACK bit

Master sends the on-demand measurement execution register address, 0xE1

Slave sends ACK bit

Master sends STOP condition

Settings register read/write examples

- Write a sound interrupt threshold value of 1956 mPa (a hexadecimal value of 0x07A4)

Master sends the START condition

Master sends 0xE2 (7-bit slave address of 0x71 combined with a R/W bit of 0)

Slave sends ACK bit

Master sends the sound interrupt threshold setting register address, 0x86

Slave sends ACK bit

Master sends least-significant data byte 0xA4

Slave sends ACK bit

Master sends most-significant data byte 0x07

Slave sends ACK bit

Master sends STOP condition

- Read what cycle time setting is currently in use.

Master sends the START condition

Master sends 0xE2 (7-bit slave address of 0x71 combined with a R/W bit of 0)

Slave sends ACK bit

Master sends the cycle time period setting register address, 0x89

Slave sends ACK bit

Master sends a repeated START condition

Master sends 0xE3 (7-bit slave address of 0x71 combined with a R/W bit of 1)

Slave sends ACK bit

Master reads one byte (the cycle period code)

Master sends NACK bit

Master sends STOP condition

Environment data read examples

Individual environment data values can be read separately via their data register addresses. Alternatively, multiple related data values (“data categories”) can be read in a single read transaction.

- Read the white light level (individual data read).

Master sends the START condition

Master sends 0xE2 (7-bit slave address of 0x71 combined with a R/W bit of 0)

Slave sends ACK bit

Master sends the white light level data register address, 0x32

Slave sends ACK bit

Master sends a repeated START condition

Master sends 0xE3 (7-bit slave address of 0x71 combined with a R/W bit of 1)

Slave sends ACK bit

Master reads one byte: this is **X**

Master sends ACK bit

Master reads one byte: this is **Y**

Master sends NACK bit
 Master sends STOP condition

Byte X is the least-significant and byte Y is the most-significant. The white light value can be calculated as:

$$\text{white light level} = X + (Y * 256)$$

- Read the Air data (category data read).

Master sends the START condition
 Master sends 0xE2 (7-bit slave address of 0x71 combined with a R/W bit of 0)
 Slave sends ACK bit
 Master sends the air data register address, 0x10
 Slave sends ACK bit
 Master sends a repeated START condition
 Master sends 0xE3 (7-bit slave address of 0x71 combined with a R/W bit of 1)
 Slave sends ACK bit
 Repeat the following two steps a total of eleven times:
 Master reads one byte
 Master sends ACK bit
 Master reads one byte
 Master sends NACK bit
 Master sends STOP condition

A total of 12 data bytes are received, from which the temperature, humidity, pressure and gas sensor resistance measurements can each be extracted. Alternatively, the data bytes can be directly converted into a C-language data structure using a type cast. Examples of both methods are given in the demo code samples at www.github.com/metriful/sensor.

7. OUTPUT SIGNAL LINES: RDY, LIT, SIT

In addition to the two-wire interface, the MS430 has three digital output signal lines: sound interrupt, light interrupt and READY (labeled SIT, LIT and RDY) which take on either of two voltage states to immediately signal a condition to the host:

- Zero voltage indicates signal assertion (interrupt has triggered, or system is ready)
- A voltage of +VPU indicates deassertion (interrupt not triggered, or system not ready). This is the voltage applied at the VPU input (either 3.3 V or 5 V, to match the host system voltage).

Use of the sound and light interrupt lines is optional, while READY is always required. These signals are explained further in Sections 10 and 13.

The interrupt lines can also be connected directly to LEDs or other circuitry, bypassing the host entirely.

8. ON-DEMAND MEASUREMENTS

Measurements of the environment data can be requested by the host when the MS430 is in standby mode. This is an “on-demand measurement”. After the measurement completes, the host can read some or all of the data using the two-wire interface. On-demand measurements are available in standby mode only, and do not provide air quality data.

Procedure for an on-demand measurement in standby mode

- i. Trigger the measurement by writing to the on-demand measurement execution register.
- ii. The MS430 will immediately deassert the READY output (voltage high) which remains deasserted while the measurement is executing. During this time all communications are ignored and the host system must wait. This measurement period lasts 0.5 seconds.
- iii. Measurement completion is signaled when the MS430 asserts the READY output (0 V).
- iv. The host can then read out all or part of the measured data (data register read).

9. CYCLE MODE

Cycle mode provides a convenient, power-efficient solution for long-term environment monitoring. Sensor data are automatically measured, analyzed and made available to the host in an endless periodic cycle, without host intervention.

A periodic toggling of the READY output signal line indicates that new data are available for reading. After initial entry to cycle mode, the two-wire communications interface remains enabled throughout. However, the data should not be read during periods where READY is deasserted (because data buffers are being updated and corrupted data could be obtained).

Initial configuration and entry into cycle mode

- i. In standby mode, before entry into cycle mode, configure the cycle time period: choose from 3 seconds, 100 seconds or 300 seconds.
- ii. Additionally, it is usual to configure interrupts (if required) in standby mode before cycle mode entry.
- iii. Enter cycle mode by sending the cycle mode entry command.
- iv. The MS430 will immediately deassert the READY signal (voltage high), indicating entry to cycle mode. The two-wire communications interface is now disabled until READY is reasserted (0 V).

Ongoing cycle mode procedure

The read-out cycle is as follows:

- i. The host waits until the READY output signal line is asserted (0V).
- ii. Data should be read by the host immediately after READY assertion, or it can ignore the data if not required.
- iii. After a time period given in Table 3, the MS430 deasserts the READY signal line (voltage high). Commands can be issued during this time but environment data should not be read.
- iv. After the remainder of the cycle time period, the cycle repeats from step i.

10. TIMING CHARACTERISTICS

Use of the READY signal for status and cycle timing

The READY signal line (RDY) is normally asserted (0 V) in standby mode. It is used in several ways to provide an alert or synchronizing signal to the host. These are:

- After device power-on or a reset command, READY is deasserted until the MS430 has finished initializing and is ready for commands in standby mode.
- When an on-demand measurement is triggered, READY is deasserted during the measurement process (during this time the two-wire interface is disabled).
- On changing between standby and cycle mode, READY is deasserted during the mode transition (during this time the two-wire interface is disabled).
- In cycle mode, READY is asserted when new data are ready for reading out by the host. READY is then deasserted for a short period on each cycle (during this time the two-wire interface is enabled but environment data should not be read).

These situations are illustrated in Figures 2 - 5 and corresponding time periods are given in Table 3.

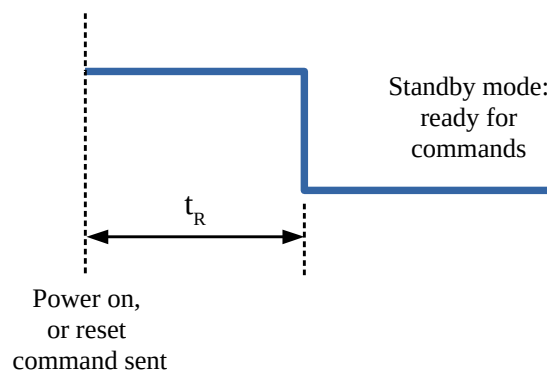

Figure 2 - READY output signal timing during power on or reset. High and low voltage levels are VPU and 0 V.

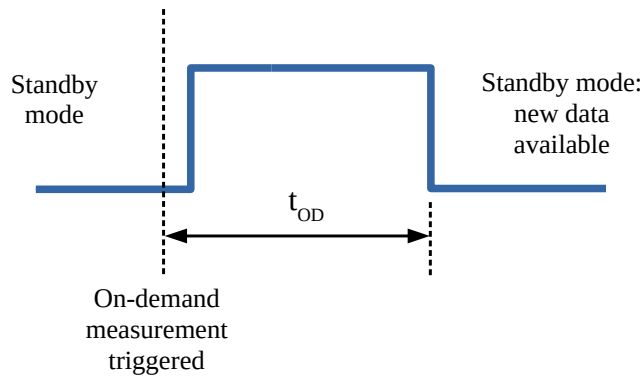

Figure 3 - READY output signal timing during an on-demand measurement. High and low voltage levels are VPU and 0 V.

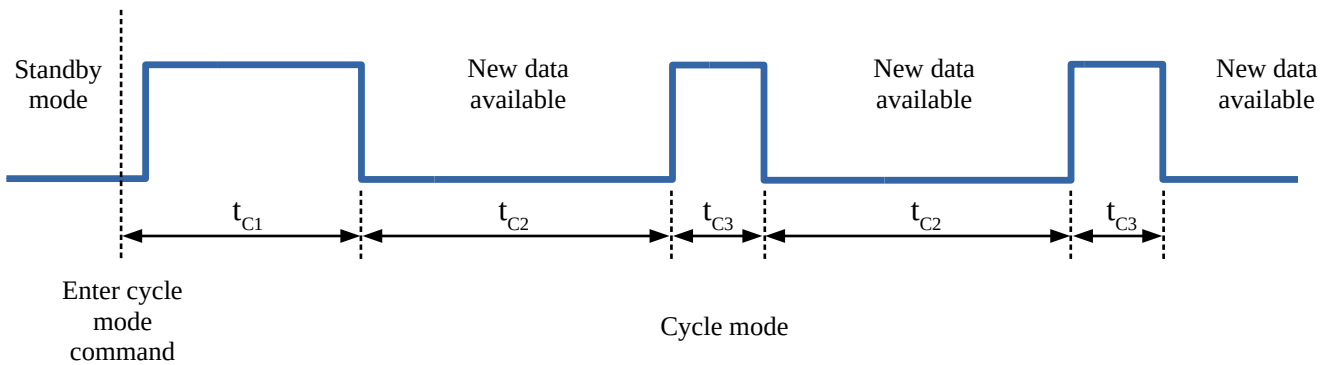

Figure 4 - READY output signal timing in cycle mode. The data cycle continues until standby mode is re-entered. High and low voltage levels are VPU and 0 V.

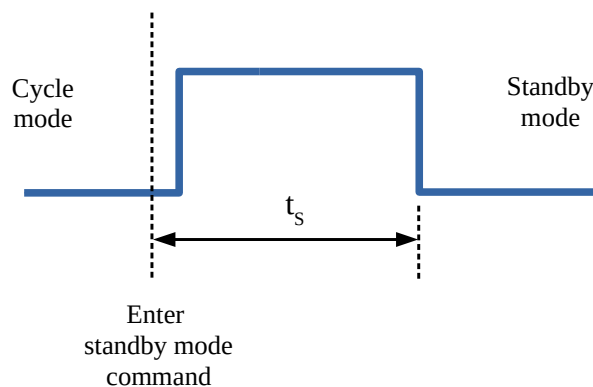

Figure 5 - READY output signal timing during a mode change from cycle to standby mode. High and low voltage levels are VPU and 0 V.

Table 3 - Maximum (worst-case) event and process times.

Time parameter	Symbol	Details	Maximum time	Time unit
System reset or power-on	t_R	Time from power on, or from reset command, to READY assertion in standby mode	260	ms
Cycle mode entry	t_{C1}	Time from cycle mode command to the first READY assertion in cycle mode (communications disabled during this time)	0.6 (3 s cycle) 2.6 (100 s cycle) 2.6 (300 s cycle)	s
Cycle mode to standby mode change	t_S	Time from standby mode command to READY assertion in standby mode (communications disabled during this time)	11.0	ms
Valid data period on each cycle	t_{C2}	The period of assertion of READY on each cycle in cycle mode, during which new output data can be read	2.95 (3 s cycle) 99.95 (100 s cycle) 299.95 (300 s cycle)	s
Invalid data period on each cycle	t_{C3}	The period of deassertion of READY on each cycle in cycle mode, during which output data should not be read	55	ms
On-demand measurement	t_{OD}	Time from an on-demand measurement command to READY assertion (communications disabled during this time)	505	ms
Processing of all other write commands*	-	Time from starting the write transaction to the command being fully processed	6	ms
Sound interrupt response time	-	Time from the sound amplitude exceeding the interrupt threshold to the output interrupt line (SIT) being asserted.	40	ms
Light interrupt response time	-	Time from the illuminance crossing the interrupt threshold to the output interrupt line (SIT) being asserted.	100	ms
Interrupt clear time	-	Time from sending the sound/light interrupt clear command to the output interrupt line (SIT/LIT) being deasserted.	10	ms

*A second command can be sent before processing of the first one is complete, as long as the second is not dependent on completion of the first. For example, a delay of 6 ms must be allowed after writing a register (for its contents to be updated) before the updated value may be read back.

11. DEVICE CHARACTERISTICS

Stresses above the absolute maximum ratings listed in Table 4 may cause permanent damage to the device. These are stress ratings only and functional operation of the device at these conditions is not implied. Exposure to maximum rating conditions for extended periods may affect device reliability.

Table 4 - Absolute maximum ratings.

Parameter	Min.	Max.	Unit
Supply voltage VIN	-0.3	6.5	V
Supply voltage VDD	-0.3	4.0	V
Voltage on PRT, RDY, SIT, LIT, SDA, SCL, VPU	-0.3	5.5	V
Storage temperature	-25	85	°C
Operating temperature	-25	85	°C
Storage air pressure	0	2000000	Pa
ESD, HBM, at any pin	-	±2	kV
ESD, MM, at any pin	-	±200	V

Table 5 - Basic characteristics.

Parameter	Min.	Typ.	Max.	Unit	Notes / conditions
Average current consumption	-	3.9	-	mA	VDD = VPU = 3.3 V 100 s cycle mode
Cycle time period variability	-	±0.3	±1.8	%	-
Two-wire interface SCL clock frequency	-	-	100	kHz	-
Low level voltage threshold on all inputs (V _{IL})	-	-	1.22	V	-
High level voltage threshold on all inputs (V _{IH})	1.88	-	-	V	-
Resistor pull-up to VPU on SCL, SDA	-	4.7	-	kΩ	5% tolerance
Resistor pull-up to VPU on RDY, SIT, LIT	-	100	-	kΩ	5% tolerance

12. PARTICLE SENSORS

The MS430 provides an input connection (labeled PRT) and data analysis algorithm for an optional air particulate matter sensor (not included with the board). Two sensors are supported: the Shinyei PPD42 and the Nova SDS011, both of which can be purchased from many suppliers worldwide.

Enabling the particle sensors

Monitoring of the particle signal input is disabled by default after a system reset or power-on. Particle monitoring is enabled by writing a value (1 or 2) to the particle sensor select register, indicating either PPD42 or SDS011.

Startup time

The MS430 applies an internal digital filter to the particle sensor data. This filter has a startup time of approximately one minute after every change of the particle sensor select register.

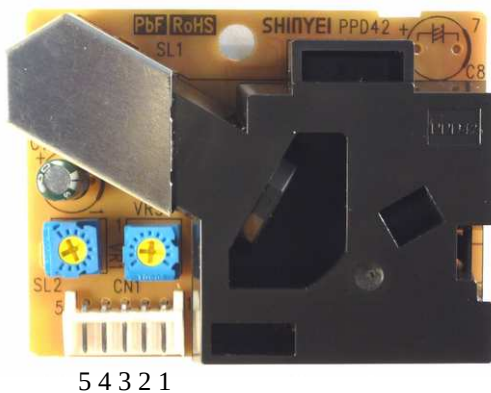

Figure 6 - PPD42 particle sensor with connector pin numbering shown



Figure 7 - SDS011 particle sensor

PPD42

The PPD42 uses a resistor heater and optical system to detect airborne particles of approximately 1 μ m diameter and larger.

Figure 6 shows the PPD42 and its 5-pin connector. Note that the connector is numbered 1 to 5 from **right to left**. Pin 1 (0 V ground) and pin 3 (5 V) provide power to the sensor, which must always be 5 V irrespective of the host system voltage. Pin 4 (signal output) connects to PRT on the MS430 board. PPD42 pins 2 and 5 are left unconnected.

For correct operation, mount the PPD42 vertically (connector pins pointing downwards) and cover the large central hole with opaque tape.

The PPD42 is sensitive to small power supply fluctuations and interference. For best results, power it with a dedicated, regulated 5 V supply. Using a 5 V output from the host system may cause increased signal noise, especially when the host is powered from a computer USB port.

SDS011

The SDS011, shown in Figure 7, uses a powered fan and laser system to detect particles of 0.3 – 10 μm in size. It has a labeled 7 pin connector; connect pins GND and 5V to the power supply and connect the MS430 PRT pin to either of the outputs labeled “25 μm ” (for particles 0.3 – 10 μm) or “1 μm ” (for particles 0.3 – 2.5 μm). The “25 μm ” output is recommended due to its larger detection rate.

13. INTERRUPTS

The MS430 interrupt system provides a way to monitor light and/or sound levels continuously. The external interrupt signal line (SIT or LIT) is asserted when a user-programmable threshold level is crossed by the measured variable. This allows a fast response (within 100 ms) and reduces the monitoring burden on the host system. The interrupt line voltage is +VPU when not asserted and 0 V when asserted. Interrupts operate in both standby and cycle modes.

Light level interrupt (output labeled LIT)

- User-programmable threshold in lux illuminance units (fractional values to two decimal places)
- Choice of triggering on light levels above or below threshold (positive or negative polarity)
- Output signal can behave as a latching interrupt or as a comparator-style logic output

Sound level interrupt (output labeled SIT)

- User-programmable threshold in mPa sound amplitude units
- Triggers on sound levels above threshold (positive polarity)
- Output signal can behave as a latching interrupt or as a comparator-style logic output

Interrupt type: latch or comparator

Both interrupts can be programmed as latch or comparator type.

- Latch: the interrupt is triggered when the signal level passes through the threshold value and it remains triggered until cleared by user command.
- Comparator: the output signal continuously updates depending on whether the level is instantaneously above or below threshold.

Interrupt configuration and enabling

The setup procedure is:

- i. Ensure the interrupt is disabled to allow changes to the settings.
- ii. Program the desired interrupt threshold level.
- iii. For light level interrupt, program the trigger polarity (whether to trigger on levels above or below threshold).
- iv. Program the interrupt type: latch or comparator style.
- v. Enable the interrupt.

Note that interrupts will trigger instantly when enabled if the trigger condition is already met.

Interrupt control

- The threshold, type (latch/comparator) and polarity (light interrupt only) may only be changed when the interrupt is disabled. Changes to these settings registers while the interrupt is enabled are ignored.
- Latch-type interrupts must be cleared by the host system before they can re-trigger. This is done by sending the light/sound interrupt clear command.

14. HOST RESET AND DEVICE INITIALIZATION

The MS430 will reset, clearing all register values to their default factory states, when power is removed or when the reset command is received.

Programming or resetting the host system will not necessarily cause a MS430 reset. A reset command should be issued at the start of any host control program, followed by a wait for READY assertion, so that the MS430 is in a known state.

15. REGISTER LISTINGS

Table 6 - Executable command registers.

Register Name	Register Address	Register data size (bytes)	Read/Write (R/W)	Valid modes	Explanation
Execute on-demand measurement	0xE1	0	W	Standby	Start a new data measurement in standby mode.
Reset	0xE2	0	W	Both	Reset system to its default state and enter standby mode.
Enter Cycle mode	0xE4	0	W	Standby	Enter cycle mode and begin periodic sensor measurements.
Enter Standby mode	0xE5	0	W	Cycle	Enter standby mode.
Clear light interrupt	0xE6	0	W	Both	Clear an asserted latch-type light interrupt (the asserted output signal line LIT will be reset to +VPU). Has no effect if comparator type is enabled.
Clear sound interrupt	0xE7	0	W	Both	Clear an asserted latch-type sound interrupt (the asserted output signal line SIT will be reset to +VPU). Has no effect if comparator type is enabled.

Table 7 - Settings registers. All values default to zero.

Register Name	Register Address	Register data size (bytes)	Read/Write (R/W)	Valid modes	Explanation of register contents value
Select particle sensor	0x07	1	R/W	Both	0 disables the PRT input 1 enables PPD42 monitoring 2 enables SDS011 monitoring Any other value is ignored. Direct changes between 1 and 2 (without 0) are ignored.
Enable light interrupt	0x81	1	R/W	Both	Zero disables the light interrupt. Any non-zero value enables it.
Light interrupt threshold	0x82	3	R/W*	Both	The light interrupt threshold in lux units. The threshold value has a 16-bit integer part and an 8-bit part representing the fractional value to two decimal places. Byte 0: integer part LSB Byte 1: integer part MSB Byte 2: fractional part Values greater than 3774 lux are ignored.
Light interrupt type	0x83	1	R/W*	Both	Zero denotes latch-type interrupt. Any non-zero value denotes comparator-type output.
Light interrupt polarity	0x84	1	R/W*	Both	Zero denotes positive (trigger when light level is greater than threshold). Any non-zero value denotes negative (trigger when light level is less than threshold).
Enable sound interrupt	0x85	1	R/W	Both	Zero disables the sound interrupt. Any non-zero value enables it.
Sound interrupt threshold	0x86	2	R/W*	Both	The 16-bit integer sound amplitude interrupt threshold in mPa units. Byte 0: threshold LSB Byte 1: threshold MSB
Sound interrupt type	0x87	1	R/W*	Both	Zero denotes latch-type interrupt. Any non-zero value denotes comparator-type output.
Set cycle mode time period	0x89	1	R/W	Standby	0 denotes 3 second cycle 1 denotes 100 second cycle 2 denotes 300 second cycle Any other value is ignored.

*** These registers can only be written when the corresponding interrupt is disabled.**

Table 8 - Environment data category registers.

Register Name	Register Address	Register data size (bytes)	Read/Write (R/W)	Valid modes	Default value	Explanation
Air data	0x10	12	R	Both	0	Read the last measured temperature, pressure, humidity and gas sensor resistance values. This is a combined read of registers 0x21 – 0x24.
Air quality data	0x11	10	R	Both	0	Read the last measured air quality index, estimated CO ₂ , breath VOC and accuracy values. This is a combined read of registers 0x25 – 0x28.
Light data	0x12	5	R	Both	0	Read the last measured illuminance and white light values. This is a combined read of registers 0x31 and 0x32.
Sound data	0x13	18	R	Both	0	Read the last measured sound pressure levels (A-weighted and frequency bands), peak sound amplitude and stability values. This is a combined read of registers 0x41 – 0x44.
Particle data	0x14	6	R	Both	0	Read the last measured particle sensor duty cycle, concentration and validity values. This is a combined read of registers 0x51 – 0x53.
Operational mode	0x8A	1	R	Both	0	Read the current device mode. The value is either 0 denoting standby, or 1 denoting cycle mode.

Table 9 - Individual environment data registers. All are read-only and are available in both standby and cycle modes.

Data name	Measurement unit (symbol)	Register Address	Register data size (bytes)	Data format
Temperature	degree Celsius (°C)	0x21	2	Byte 0: sign-encoded integer part Byte 1: fractional part (one decimal place)
Pressure	pascal (Pa)	0x22	4	32-bit integer
Humidity	percent relative (% RH)	0x23	2	Byte 0: integer part Byte 1: fractional part (one decimal place)
Gas sensor resistance	ohm (Ω)	0x24	4	32-bit integer
Air quality index (AQI)	Number between 0 – 500	0x25	3	Byte 0: integer part LSB Byte 1: integer part MSB Byte 2: fractional part (one decimal place)
Estimated CO ₂ concentration	Parts per million (ppm)	0x26	3	Byte 0: integer part LSB Byte 1: integer part MSB Byte 2: fractional part (one decimal place)
Equivalent breath VOC concentration	Parts per million (ppm)	0x27	3	Byte 0: integer part LSB Byte 1: integer part MSB Byte 2: fractional part (two decimal places)
AQI accuracy	Number between 0 – 3	0x28	1	An 8-bit integer code denoting accuracy state of the smart air quality algorithm: 0 = Not valid and/or initializing 1 = Low accuracy 2 = Medium accuracy 3 = High accuracy
Illuminance	lux (lx)	0x31	3	Byte 0: integer part LSB Byte 1: integer part MSB Byte 2: fractional part (two decimal places)
White light level	Number between 0 – 65535	0x32	2	16-bit integer.

Continued on the next page

Table 9 continued - Individual environment data registers.

Data name	Measurement unit (symbol)	Register Address	Register data size (bytes)	Data format
A-weighted sound pressure level	A-weighted decibel (dBA)	0x41	2	Byte 0: integer part Byte 1: fractional part (one decimal place)
Sound pressure level (frequency bands)	decibel (dB)	0x42	12	Bytes 0 – 5 are the six integer parts for bands 1 – 6 respectively. Bytes 6 – 11 are the fractional parts to one decimal place for bands 1 – 6 respectively.
Peak sound amplitude (since last read)	millipascal (mPa)	0x43	3	Byte 0: integer part LSB Byte 1: integer part MSB Byte 2: fractional part (two decimal places)
Sound measurement stability	Number 0 or 1	0x44	1	An 8-bit integer code denoting start-up state of the microphone: 0 = not stable 1 = stable The start-up period lasts 1.5 s from system reset or power-on. Sound measurement accuracy is reduced during this time due to microphone initialization.
Particle sensor duty cycle	Percent (%)	0x51	2	Byte 0: integer part Byte 1: fractional part (two decimal places)
Particle concentration	PPD42: particles per liter (ppL) SDS011: micrograms per cubic meter ($\mu\text{g}/\text{m}^3$)	0x52	3	Byte 0: integer part LSB Byte 1: integer part MSB Byte 2: fractional part (two decimal places, always zero for PPD42)
Particle data valid	Number 0 or 1	0x53	1	An 8-bit integer code denoting state of the digital filter for particle data: 0 = initializing 1 = likely to have settled

16. SENSOR COMPONENTS

Table 10 - Sensor components used in the MS430 product.

Measurement	Manufacturer	Part number
Air quality	Bosch Sensortec	BME680
Light	Vishay	VEML6030
Sound	Knowles	SPH0645LM4H-B
Particulate matter (optional)	Shinyei or Nova	PPD42 or SDS011

17. RoHS

Metriful Ltd. confirms that the MS430 sensor board product:

- is compliant with the applicable requirements of the Restriction of Hazardous Substances (RoHS) Directive 2011/65/EU and former 2002/95/EC as amended by 2015/863/EU.
- is considered a component under RoHS, therefore CE marking and EU declaration of conformity (2011/65/EU Art 7) do not apply, as reported in RoHS II FAQ (Rev 2012 Q7.3).

18. DISCLAIMER

ALL PRODUCTS, PRODUCT SPECIFICATIONS AND DATA ARE SUBJECT TO CHANGE WITHOUT NOTICE TO IMPROVE RELIABILITY, FUNCTION OR DESIGN, OR OTHERWISE.

Metriful Ltd., its affiliates, agents, and employees, and all persons acting on its or their behalf (collectively, “Metriful”), disclaim any and all liability for any errors, inaccuracies or incompleteness contained in any datasheet or in any other disclosure.

Metriful makes no warranty, representation or guarantee regarding the suitability of the products for any particular purpose or the continuing production of any product. To the maximum extent permitted by applicable law, Metriful disclaims (i) any and all liability arising out of the application or use of any product or data, (ii) any and all liability, including without limitation special, consequential or incidental damages, and (iii) any and all implied warranties, including warranties of fitness for particular purpose, non-infringement and merchantability.

Statements regarding the suitability of products for certain types of applications are based on Metriful’s knowledge of typical requirements that are often placed on Metriful products in generic applications. Such statements are not binding statements about the suitability of products for a particular application. It is the customer’s responsibility to validate that a particular product is suitable for use in a particular application.

Parameters provided in datasheets and / or specifications may vary in different applications and performance may vary over time. All operating parameters, including typical parameters, must be validated for each customer application by the customer. Product specifications do not expand or otherwise modify Metriful’s terms and conditions of purchase, including but not limited to the warranty expressed therein. Product photographs and diagrams are for illustration purposes only and may differ from the real product appearance.

Metriful products are not designed for use in medical, life-saving, safety, or life-sustaining applications or for any other application in which the failure of the Metriful product could result in personal injury or death. Customers using or selling Metriful products for use in such applications do so at their own risk. No information contained in any Metriful document or disclosure constitutes health or safety advice.

No license, express or implied, by estoppel or otherwise, to any intellectual property rights is granted by this document or by any conduct of Metriful. Product names and markings noted herein may be trademarks of their respective owners.

Document revision: 2.0

Document release date: 6 September 2020

Document number: MET-DS001-02

© 2020 Metriful Ltd.